

# Alpha<sup>®</sup> Wet Blade Cutting Kit Instruction Manual

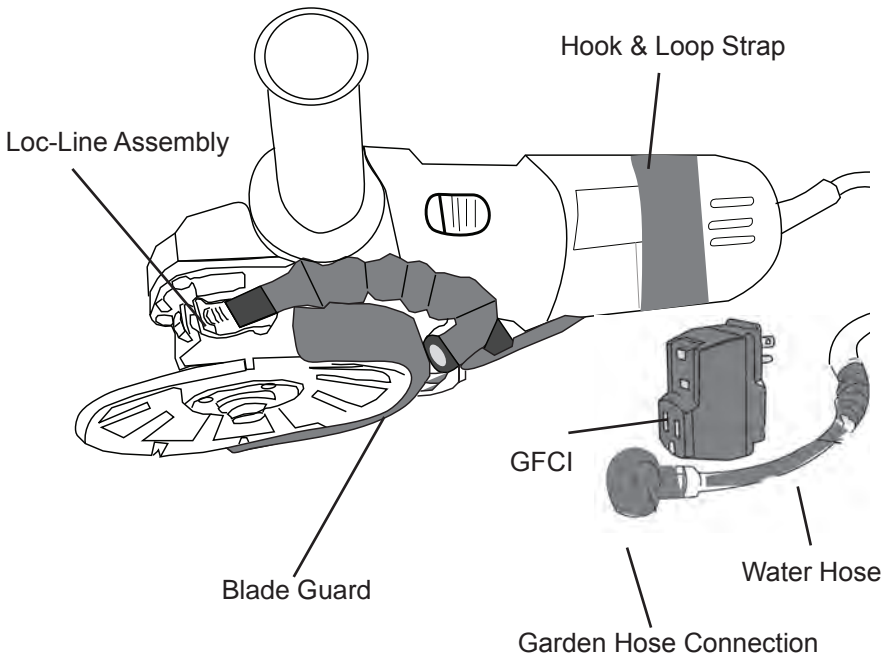

*\*Tool and Blade sold separately*

**Part No: WBC5KIT/WBC6KIT**  
**Version 3**

 **Alpha Professional Tools<sup>®</sup>**

103 Bauer Drive, Oakland, NJ 07436 • 800-648-7229 • Fax: 800-286-0114  
[www.alpha-tools.com](http://www.alpha-tools.com)

## ►TABLE OF CONTENTS

WBC5KIT/WBC6KIT Schematics .....	3
WBC5KIT Parts List.....	3
WBC6KIT Parts List.....	4
Instructions .....	4
Creating Thread Holes for the Protective Guard .....	5
Assembly of WBC5KIT/WBC6KIT Guard .....	5
Installation of WBC5KIT/WBC6KIT Guard .....	6
Attaching Water Hose Assembly To Loc-Line.....	7
Hook & Loop Strap Installation .....	8
Installation of EasyOn-EasyOff Sleeve.....	8
Installation of GFCI.....	9
Testing In-Line GFCI Unit .....	9
Installation of Quick Connect Adapter .....	10
Completed Assembly.....	10
Compatibility Chart for WBC5KIT/WBC6KIT .....	11

### ► SERVICE

Use only Alpha Professional Tools® accessories and spare parts. Should components which have been described need to be exchanged, please contact your dealer or Alpha Professional Tools®.

### CAUTION!

- Attach the Wet Blade Cutting Kit correctly by following the procedure in this instructional manual.
- During operation, be sure to wear personal safety equipment.

### ► NEED MORE INFORMATION

For information on Alpha Professional Tools® complete product line, visit us on the web at [www.alpha-tools.com](http://www.alpha-tools.com).

## ► WBC5KIT/WBC6KIT SCHEMATICS

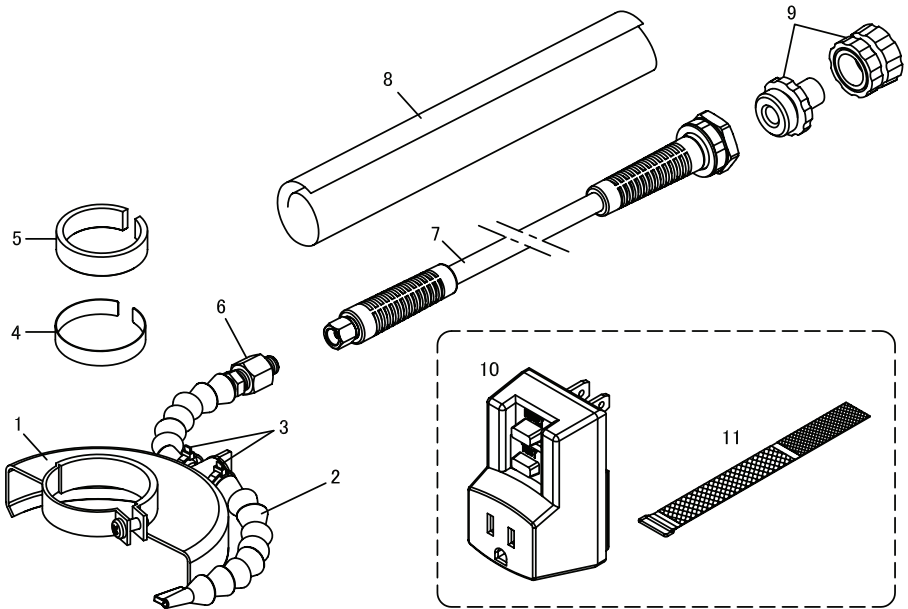

## ► WBC5KIT PARTS LIST

ITEM NO.	PART NO.	DESCRIPTION	QUANTITY
1	140007	5" Safety Guard	1
2	140004	Loc-Line Assembly	1
3	PDH-CABLETIES	Plastic Tie	2
4	133778	Stainless Steel Collar	1
5	133779	Plastic Collar	1
6	133780	Adapter (1/4 NPT>>>M10*P1.0)	1
7	210129	Water Hose Assembly (15ft./4.5m)	1
8	210124	Memory Wrap (3ft./1m)	1
9	658-113	Quick Connect Adapter	1
10	GFCI-1	GFCI Plug (120V)	1
11	140003	Hook & Loop Strap	1

**► WBC6KIT PARTS LIST**

ITEM NO.	PART NO.	DESCRIPTION	QUANTITY
1	133784	6" Safety Guard	1
2	133785	Loc-Line Assembly	1
3	PDH-CABLETIES	Plastic Tie	2
4	133778	Stainless Steel Collar	1
5	133779	Plastic Collar	1
6	133780	Adapter (1/4 NPT>>>M10*P1.0)	1
7	210129	Water Hose Assembly (15ft./4.5m)	1
8	210124	Memory Wrap (3ft./1m)	1
9	133773	Quick Connect Adapter	1
10	GFCI-1	GFCI Plug (120V)	1
11	140003	Hook & Loop Strap	1

**► INSTRUCTIONS**

Alpha Professional Tools® provides the highest quality parts and manufacturing techniques in the manufacture of this product. In order to obtain the maximum effectiveness and provide the highest degree of safety, it is necessary to review and follow these instructions carefully before using the tool.

## ► CREATING THREAD HOLES FOR THE PROTECTIVE GUARD

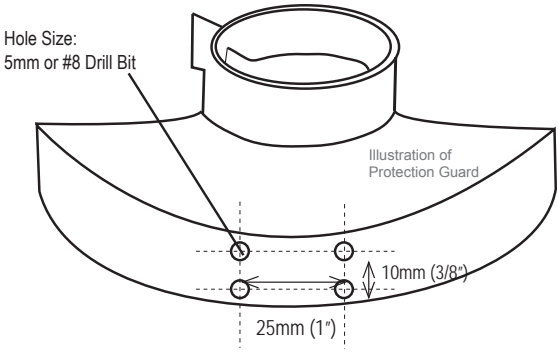

## ► ASSEMBLY OF WBC5KIT/WBC6KIT GUARD

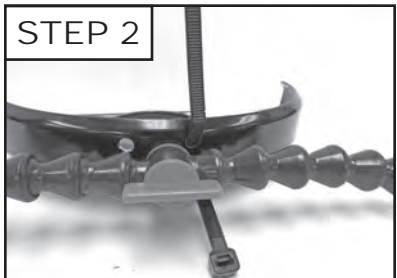

1. Thread Plastic Tie through the drilled holes in the Safety Guard. (If using another grinders safety guard, the guard must be altered to accommodate the Plastic Ties as shown above).

2. Place Loc-Line Assembly between the holes on the Safety Guard and tighten in place with the Plastic Ties.



3. Repeat Steps 1 and 2 to completely secure the Loc-Line Assembly to the Safety Guard.

4. Trim the Plastic Ties with pliers as shown above.

Completed  
Guard Assembly



## ► INSTALLATION OF WBC5KIT/WBC6KIT GUARD

1. Select the collar that is compatible for the make and model of the grinder (Refer to the Compatibility Chart)



2. Place the collar on the neck of the grinder.

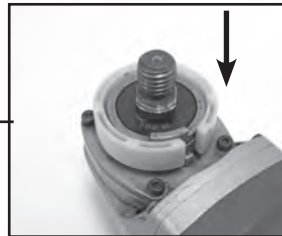

3. Position the Safety Guard over the collar with the shield facing backwards. Push Down until the Safety Guard is firmly seated on the base of grinders neck.

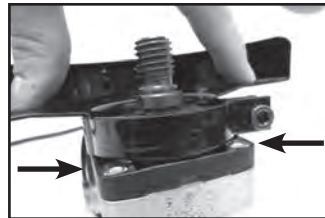
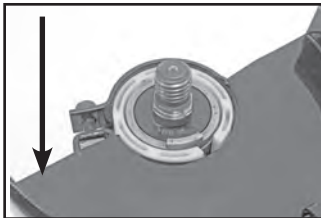

4. Secure the Safety Guard to the grinder by tightening the Hex Screw using a 3/16 Hex Wrench.

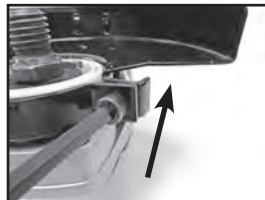
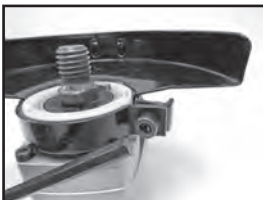

## ► ATTACHING WATER HOSE ASSEMBLY TO LOC-LINE

1. Bend the Loc-Line Assembly to conform to the Water Hose Assembly.



2. Attach and tighten the Adapter on the end of the Loc-Line.

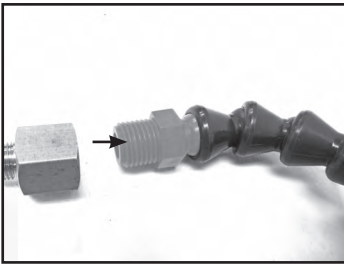

3. Attach and tighten the Water Hose Assembly onto the Adapter.

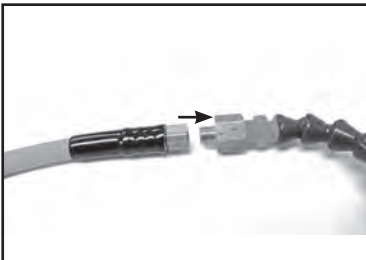

## ► HOOK & LOOP STRAP INSTALLATION

1. Place the grinder on top of the Hook & Loop Strap.



2. Position the Hook & Loop Strap around the Water Hose Assembly and the grinder body.

**NOTE:** Position the strap away from the vent ports of the grinder.



## ► INSTALLATION OF EASYON-EASYOFF SLEEVE

1. Wrap the EasyOn-EasyOff Sleeve around the Water Hose Assembly and electrical cord.
2. Finish the wrapping procedure until the entire EasyOn-EasyOff sleeve is secured.

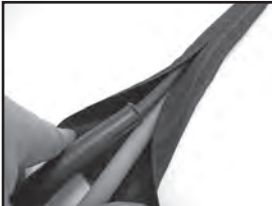



## ► INSTALLATION OF GFCI

1. Install the GFCI to the grinders power cord as shown. Connect to power and check the GFCI for proper function.



## ► TESTING IN-LINE GFCI UNIT

1. Connect GFCI to a single phase AC power supply
2. Verify that the indicator lens shows red (indicating output voltage)
3. Press the test button to verify that the red in the indicator lens disappears
4. Press the reset button to verify the red indicator is visible
5. The GFCI is now ready to use

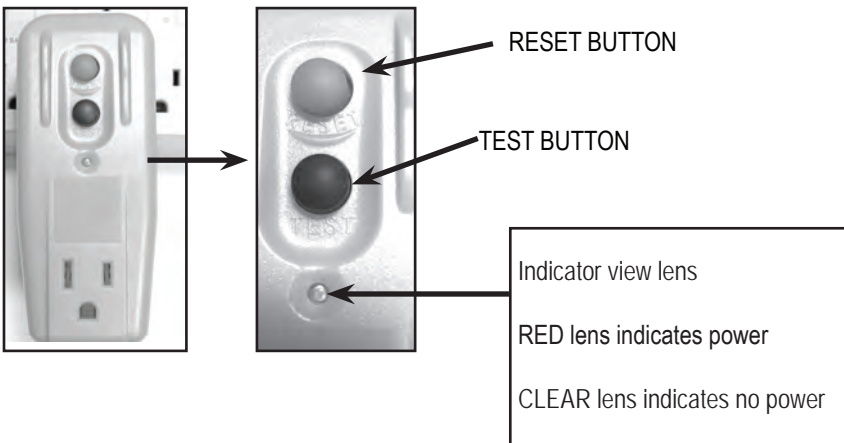

## ► INSTALLATION OF QUICK CONNECT ADAPTER

1. Secure the Quick Connect Adapter to the Water Hose Assembly.

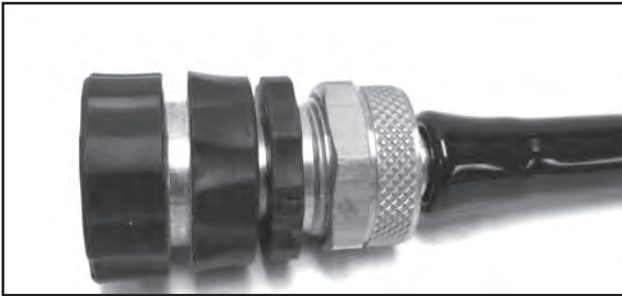
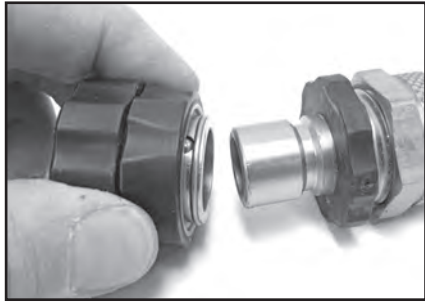
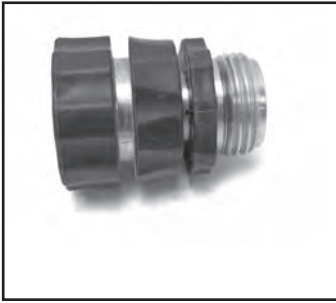

## ► COMPLETED ASSEMBLY



## ► HELPFUL HINT

*The spray nozzle can be easily adjusted to direct the proper amount of water distribution onto the blade based on the operator's cutting application.*

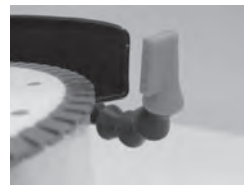
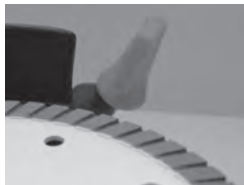

## ► COMPATIBILITY CHART

BRAND	SIZE	MODEL		
MAKITA®	4-1/2"	GA4530 ser.		
		GA4534		
		4557 ser.		
		4564 ser.		
	5"	GA5010Z		
		GA5020 (Y)		
		9558PB		
	6"	9565 ser.		
		GA6010Z		
		GA6020		
METABO®	4-1/2"	W8-115 ser.		
	5"	W8-125 Quick		
		W11-125 Quick		
		WA11-125 Quick		
		WE9-125 Quick		
		WE14-125 ser.		
		WP8-125 Quick Protect		
		WP11-125 Quick Protect		
		WEPA14-125 Quick Protect		
	6"	W11-150 Quick		
		WE14-150 Quick		
		WER14150 Quick Protect		
		WEPA14-150 Quick Protect		
		WP11-150 Quick Protect		
		BOSCH	4-1/2"	1800
				1810 ser.
AG40 ser.				
5"	1801			
	1803EVS			
	1811PS			
	1821 ser.			
6"	AG50 ser.			
	1806E			
	1812PSD			
	AG60 ser.			

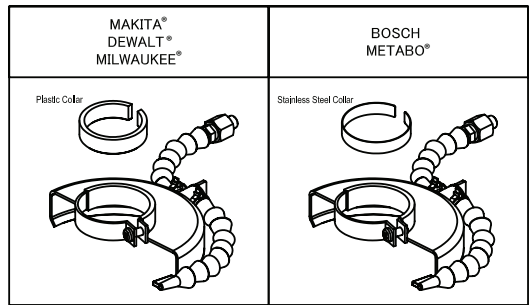

DEWALT®	4-1/2"	D28110	
		D28112	
		D28402	
	4-1/2" / 5"	D28065	
		D28114 (N)	
		D28115 (N)	
		D28131	
		D28140	
6"	D28144 (N)		
	D28065 (N)		
	D28066N		
	MILWAUKEE®	4/1/2"	6130-33
6140-30			
6146-30			
6146-31			
6146-33			
6147-110			
6147-31			
6121-30			
6121-31			
5"			6117-30
			6117-31
	6117-33		
	6117-33D		
	6121-31A		
6"	6124-30		
	6124-31		
	6161-30		
	6161-31		
	6161-33		



103 Bauer Drive, Oakland, NJ 07436 • 800-648-7229 • Fax: 800-286-0114  
[www.alpha-tools.com](http://www.alpha-tools.com)

Copyright © 2018 Alpha Professional Tools. All rights reserved.